

> **PLISSÈ ZERO**

Articolo: ZANL0088



Zanzariera per porte-finestre di frequente passaggio. La minima barriera al pavimento agevola il transito. La semplicità di montaggio e smontaggio facilita una completa pulizia del vano e del prodotto. È realizzabile a un'anta, due ante con chiusura centrale o a seguire, tre e quattro ante.



MANIGLIA
A PENDOLO



MANIGLIA
A SBALZO



KIT IMPACT

LEGENDA ICONE VEDI PAG. 158



COLORI ACCESSORI NYLON

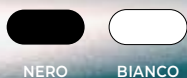

NERO BIANCO

COLORI ALLUMINIO RAL STANDARD

* FINITURA SEMILUCIDA ▲ FINITURA RUVIDA



BIANCO 9010 BIANCO 9016 AVORIO 1013 MARRONE 8017 T. DI MORO CHIARO T. DI MORO SCURO GRIGIO 7001 GRIGIO 7016 NERO 9005 VERDE 6005 VERDE 6009 BRONZO VERNICIATO ARGENTO OX

* ▲ * ▲ * ▲ * ▲ * ▲ * ▲

MARMO

LEGNO



VERDE MARMO MARRONE MARMO GRIGIO MARMO NOCE RUVIDO RENOLIT CHIARO RENOLIT SCURO CILIEGIO 317-70R DOUGLAS RUVIDO

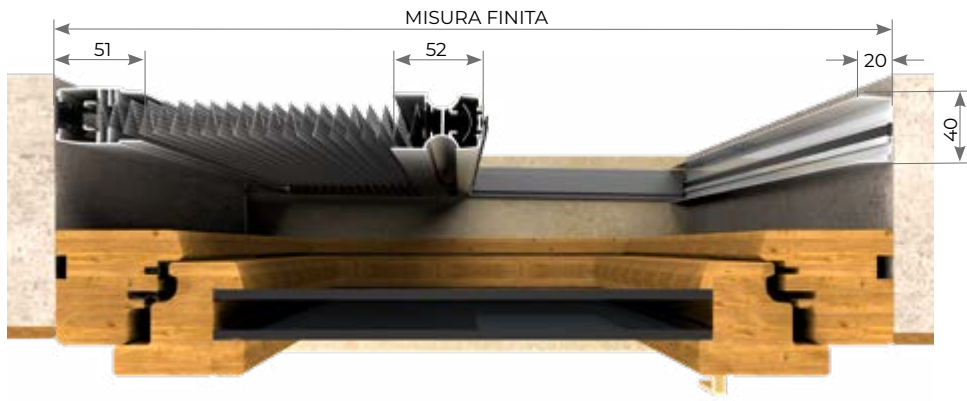

IMPACT

Il blocco magnetico IMPACT permette a zanzariera disattivata di bloccare la maniglia della zanzariera verso il dorso, contenendo lo spessore delle pieghe. La visione della rete a zanzariera disattivata viene ridotta al minimo ingombro

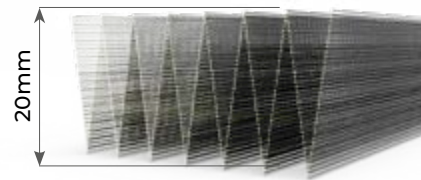
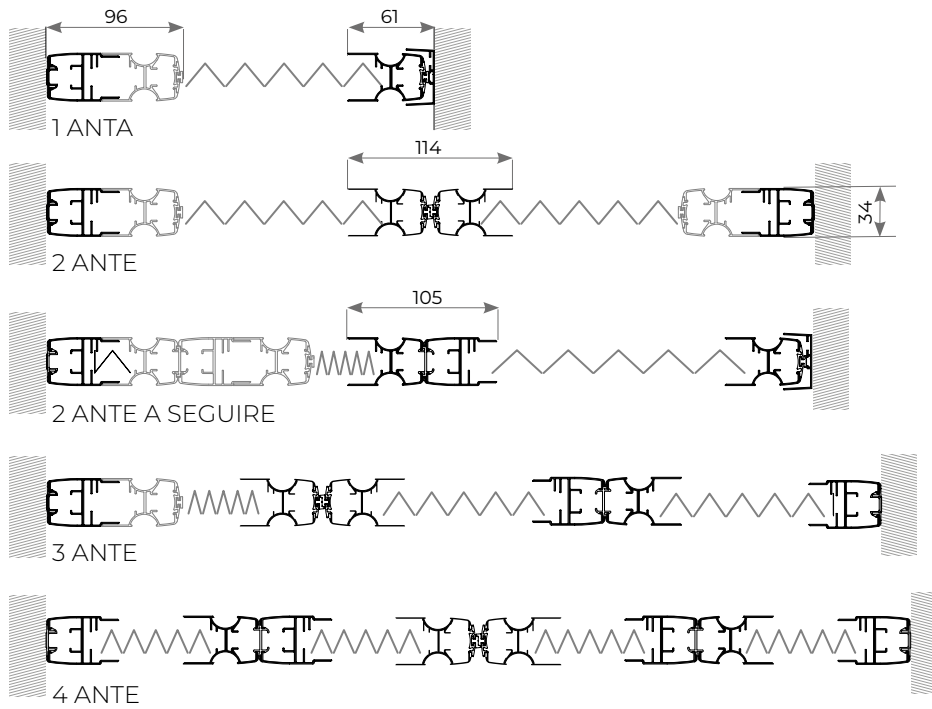

PIEGA RETE

+ INCASSO - C DOUBLE FACE

MISURA FINITA: verrà fornita con le stesse misure ordinate (max. ingombro)

MISURA LUCE: verrà fornita e addebitata con misure maggiorate: larghezza + 100mm, altezza + 50mm. Dettagli pagina 220.

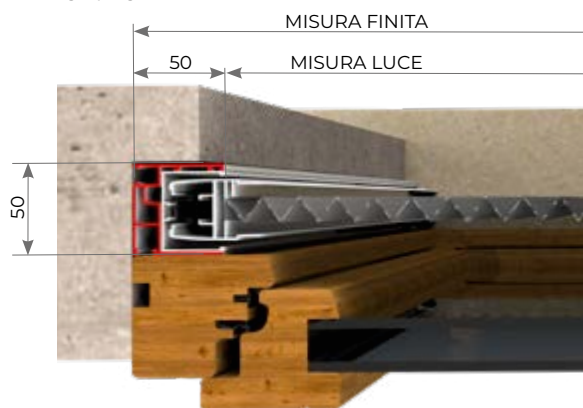

+ INCASSO - E PERSIANA

MISURA FINITA: verrà fornita con le stesse misure ordinate (max. ingombro)

MISURA LUCE: verrà fornita e addebitata con misure maggiorate: larghezza + 82mm, altezza + 41mm. Dettagli pagina 232.

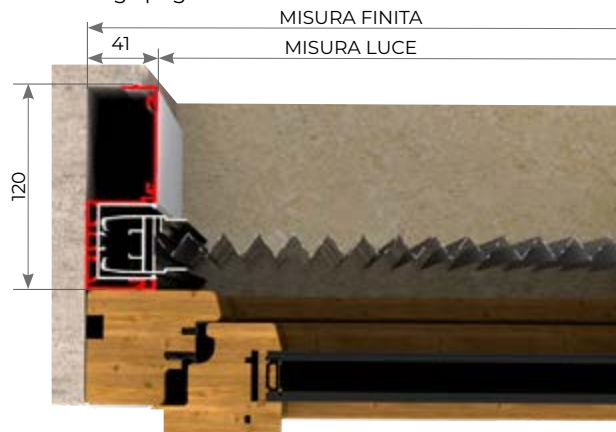

+ INCASSO - D TAPPARELLA

MISURA FINITA: verrà fornita con le stesse misure ordinate (max. ingombro)

MISURA LUCE: verrà fornita e addebitata con misure maggiorate: larghezza + (40x2)mm, altezza pari a misura finita.

Dettagli pagina 224.

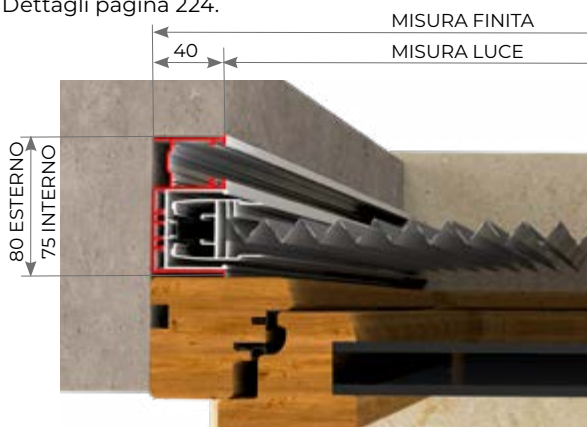

+ INCASSO - D TAPPARELLA CON DISTANZIALE

MISURA FINITA: verrà fornita con le stesse misure ordinate (max. ingombro)

MISURA LUCE: verrà fornita e addebitata con misure maggiorate: larghezza + (40x2)mm, altezza pari a misura finita.

Dettagli pagina 228.



+ INCASSO - A 47

MISURA FINITA: verrà fornita con le stesse misure ordinate (max. ingombro)

MISURA LUCE: verrà fornita e addebitata con misure maggiorate: larghezza + (40x2)mm, x altezza + 40mm. Dettagli pagina 216.

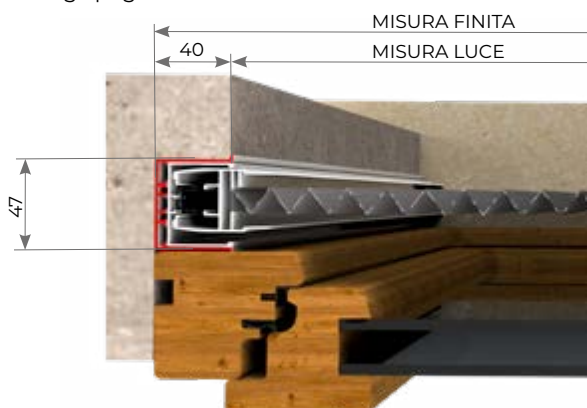

+ INCASSO - B 50

MISURA FINITA: verrà fornita con le stesse misure ordinate (max. ingombro)

MISURA LUCE: verrà fornita e addebitata con misure maggiorate: larghezza + (39x2)mm, x altezza + 39mm. Dettagli pagina 218.

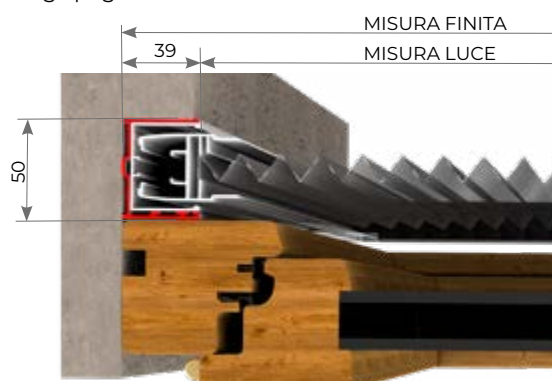

+ INCASSO - F 45

L'incasso 45 predispone l'inserimento della zanzariera su porte-finestre. **Ha un ingombro di 45mm.**

MISURA FINITA: verrà fornita con le stesse misure ordinate (max. ingombro)

MISURA LUCE: verrà fornita e addebitata con misure maggiorate: larghezza + 70mm.



+ INCASSO - G 40

L'incasso 40 predispone l'inserimento della zanzariera su porte-finestre.

Ha un ingombro di 40mm.

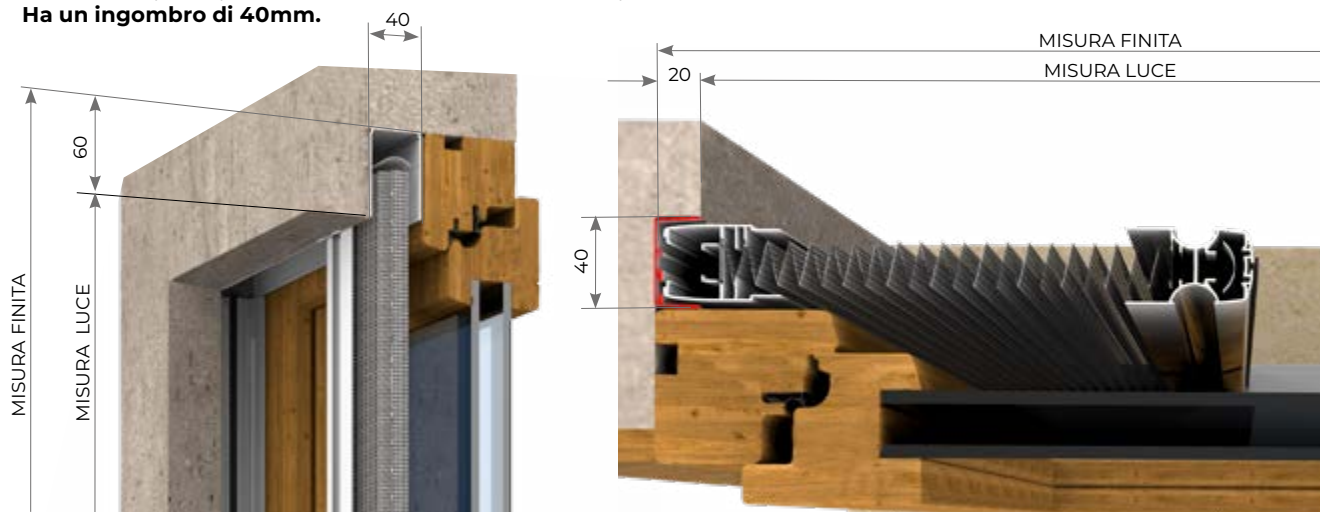

MANIGLIE DA INCASSO

In abbinamento agli incassi, si consiglia l'uso delle maniglie da incasso: maniglia a sbalzo o maniglia a pendolo.

MANIGLIA A PENDOLO



MANIGLIA A SBALZO

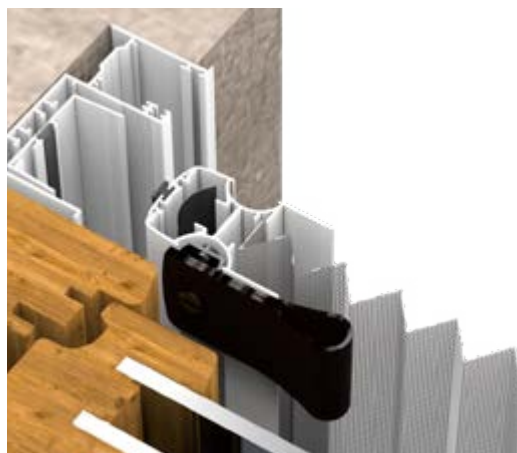

> **PLISSÈ PLUS**

Articolo: ZANL0108



Zanzariera per porte-finestre di frequente passaggio.

La minima barriera a pavimento facilita il transito.

La facilità di installazione e disinstallazione agevola la pulizia completa del vano e del prodotto.

La particolare concezione costruttiva consente l'installazione in nicchia e frontale senza profili o attrezzature aggiuntive.



KIT IMPACT

LEGENDA ICONE VEDI PAG. 158

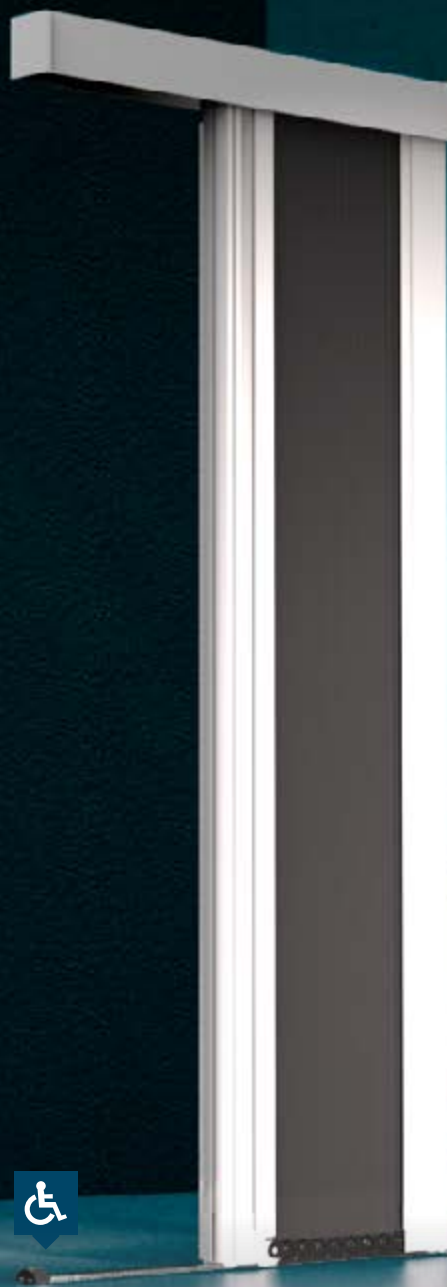

COLORI ACCESSORI NYLON



NERO

BIANCO



COLORI ALLUMINIO RAL STANDARD da verniciare su richiesta.

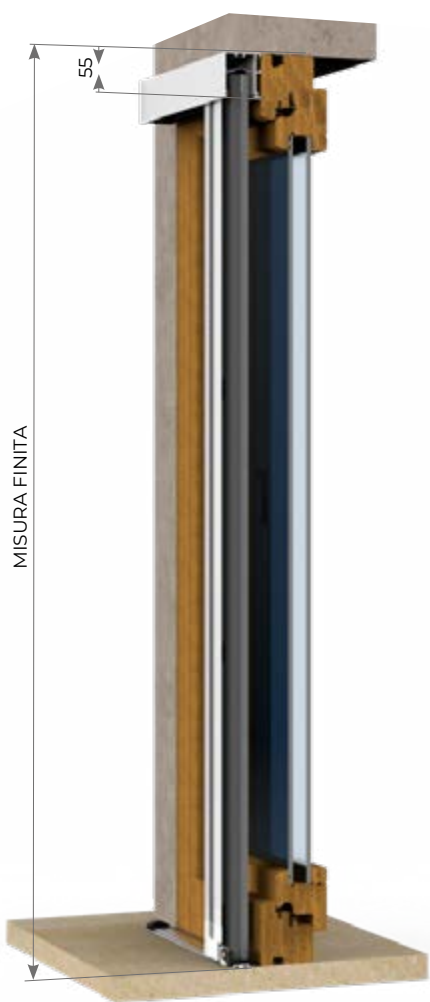

MISURE CONSIGLIATE mm

PLISSÈ PLUS 1 ANTA	L	H
MIN	900	2100
MAX	2000	3000



IMPACT

La serratura magnetica IMPACT permette di bloccare la maniglia della zanzariera verso la parte posteriore quando la zanzariera è disattivata, limitando così lo spessore delle pieghe. La visibilità della rete quando la zanzariera è disattivata è ridotta al minimo.

 la misura dell'altezza deve essere sempre maggiore della larghezza di 150mm.

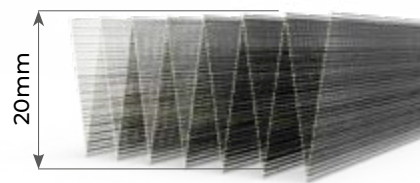

PIEGA RETE

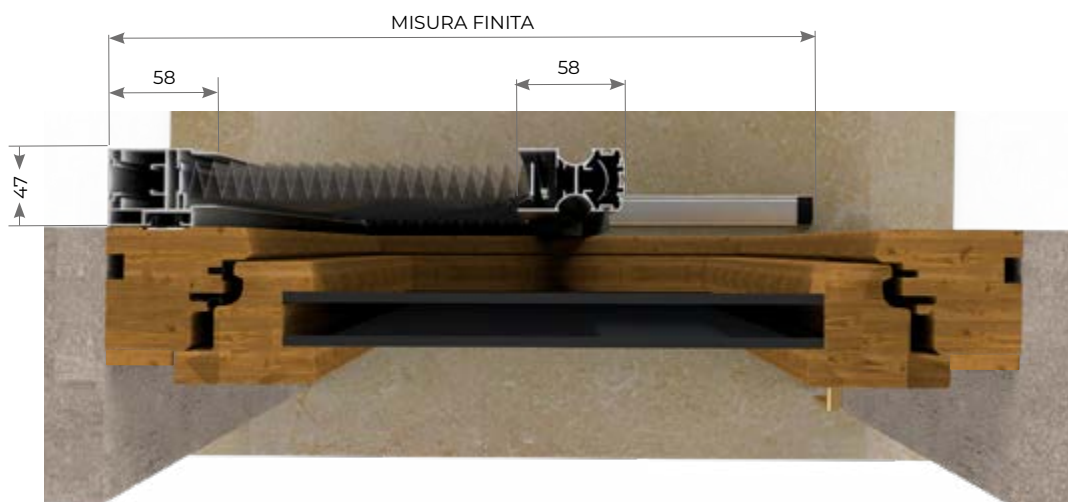

 > **0.18**



PATENTED: 002560003
PATENTED: RM 2015A000099

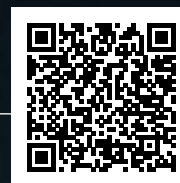

Articolo: ZANL0089

Zanzariera con rete plissettata, a comando frizionato. Con un ingombro di soli 18mm diventa la soluzione ottimale per l'installazione in spazi ridotti. La guida a terra di appena 7mm rende il passaggio agevole.

È disponibile in due versioni, tutte fornite con rete nera e su richiesta con rete grigia.

0.18 LATERALE, particolarmente indicata per porte-finestre, ha un movimento laterale e prevede la realizzazione a una o due ante.

0.18 REVERSIBILE è una zanzariera per porte-finestre.

La sua particolare struttura, caratterizzata da due profili scorrevoli che permettono l'impacchettamento e l'estensione totale della rete da entrambi i lati, la rende molto indicata in abbinamento agli infissi scorrevoli.



FORO DRENANTE

COLORI ACCESSORI NYLON



NERO

BIANCO

COLORI ALLUMINIO RAL STANDARD

* FINITURA SEMILUCIDA

▲ FINITURA RUVIDA



BIANCO 9010

BIANCO 9016

BIANCO CREMA 9001

AVORIO 1013

MARRONE 8017

T. DI MORO CHIARO

T. DI MORO SCURO

GRIGIO 7001

GRIGIO 7016

NERO 9005

NERO MICACEO

VERDE 6005

VERDE 6009

* ▲

*

* ▲

* ▲

▲

*

*

▲

RAL STANDARD

MARMO

LEGNO



BRONZO VERNICIATO

ARGENTO OX

VERDE MARMO

MARRONE MARMO

GRIGIO MARMO

NOCE RUVIDO

RENOLIT CHIARO

RENOLIT SCURO

CILIEGIO 317-70R

CILIEGIO 317-70R

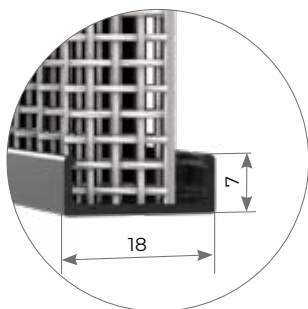
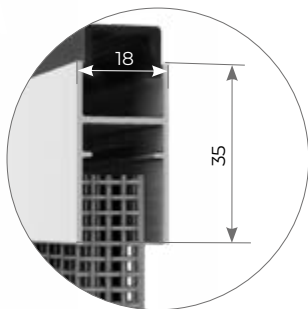
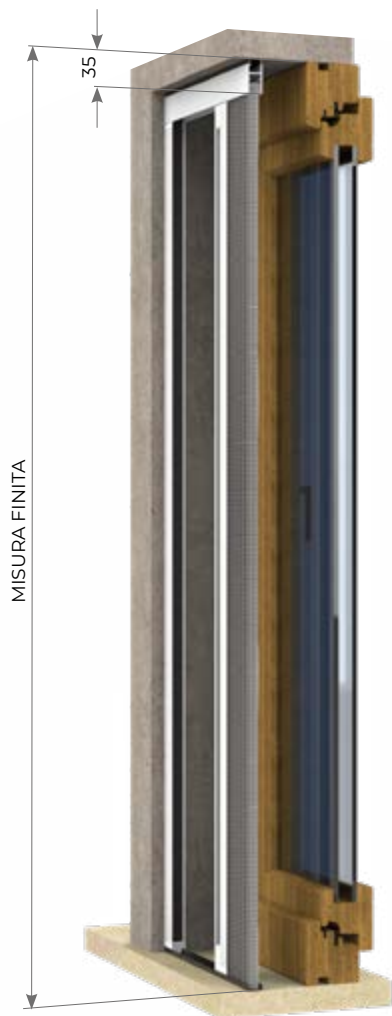

MISURE CONSIGLIATE mm

MISURA FINITA: la zanzariera verrà fornita con le stesse misure ordinate.

MISURA LUCE: (specificare) la zanzariera verrà fornita 3mm in meno sull'altezza.

0.18 1 ANTA LATERALE		
	L	H
MIN	-	600
MAX	2000	2600
0.18 REVERSIBILE		
	L	H
MIN	-	600
MAX	2400	2600



PIEGA RETE

RETE NERA STANDARD
A RICHIESTA GRIGIA

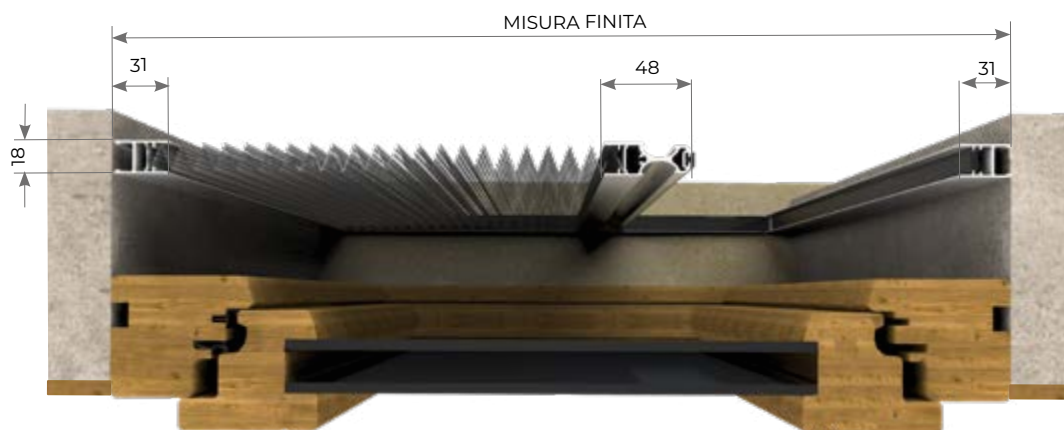

PLISSETTATE

VERSIONE 2 ANTE

Articolo: ZANL0089

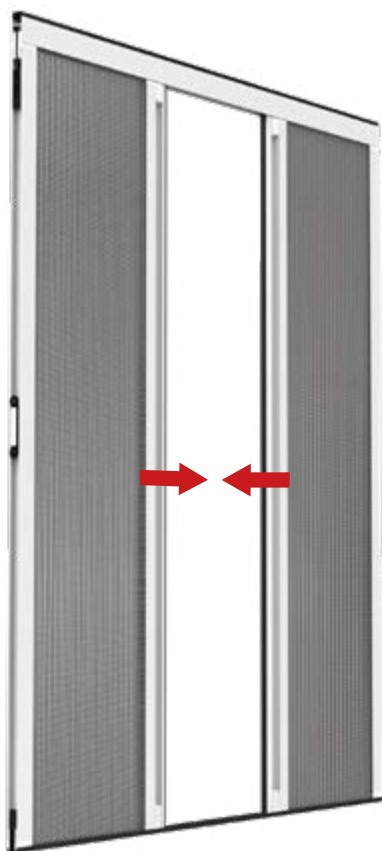

VERSIONE REVERSIBILE

Articolo: ZANL0091

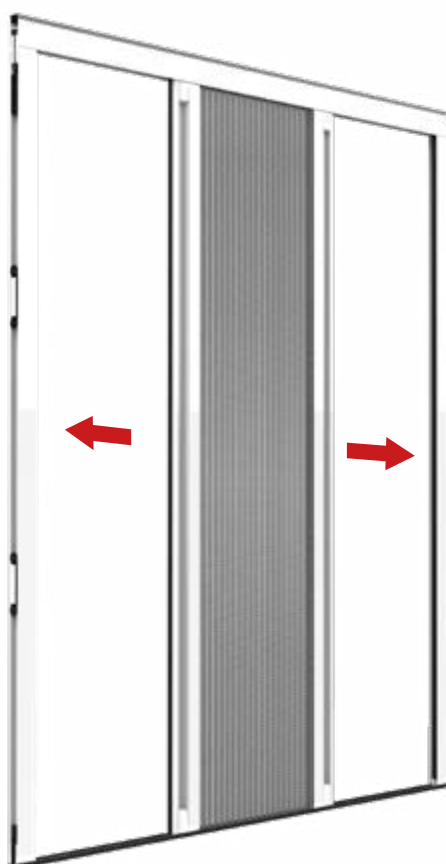

> 0.18 - ADATTATORE 45

ADATTATORE

MISURA FINITA: la zanzariera + l'adattatore verranno forniti con le misure ordinate max ingombro.

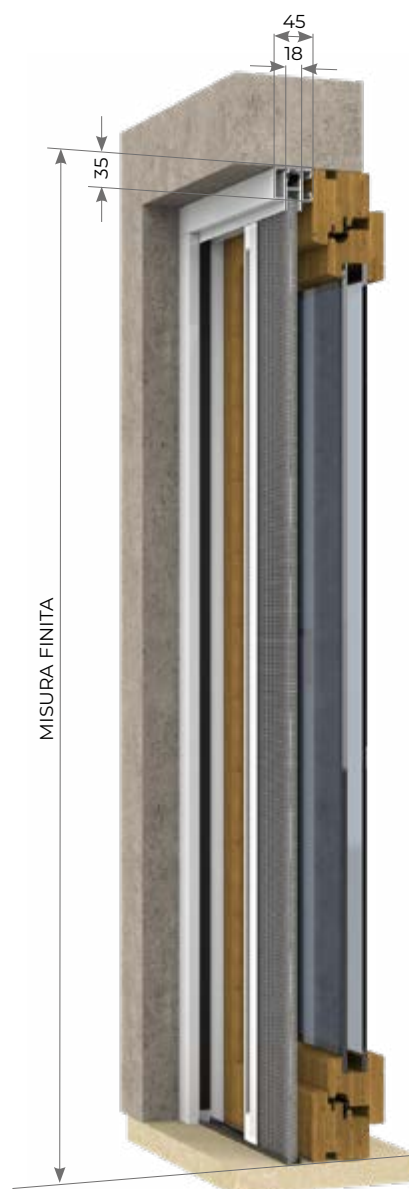

PLISSETTATE

+ INCASSO - C DOUBLE FACE

MISURA FINITA: verrà fornita con le stesse misure ordinate (max. ingombro)

MISURA LUCE: verrà fornita e addebitata con misure maggiorate: larghezza + 100mm, altezza + 50mm.
 Dettagli pagina 220.



+ INCASSO - D TAPPARELLA

MISURA FINITA: verrà fornita con le stesse misure ordinate (max. ingombro)

MISURA LUCE: verrà fornita e addebitata con misure maggiorate: larghezza + (40x2)mm, altezza pari a misura finita.
 Dettagli pagina 224.

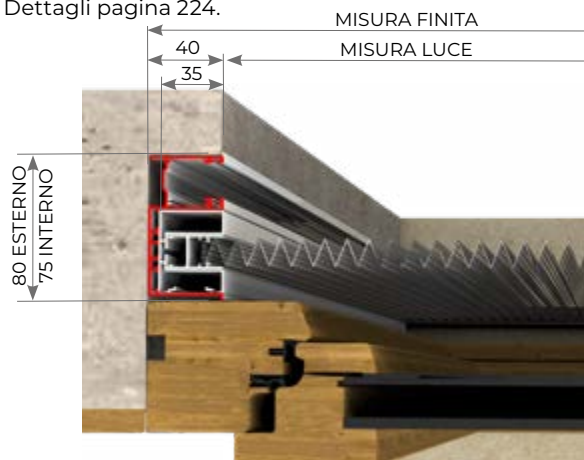

+ INCASSO - D TAPPARELLA CON DISTANZIALE

MISURA FINITA: verrà fornita con le stesse misure ordinate (max. ingombro)

MISURA LUCE: verrà fornita e addebitata con misure maggiorate: larghezza + (40x2)mm, altezza pari a misura finita.
 Dettagli pagina 228.

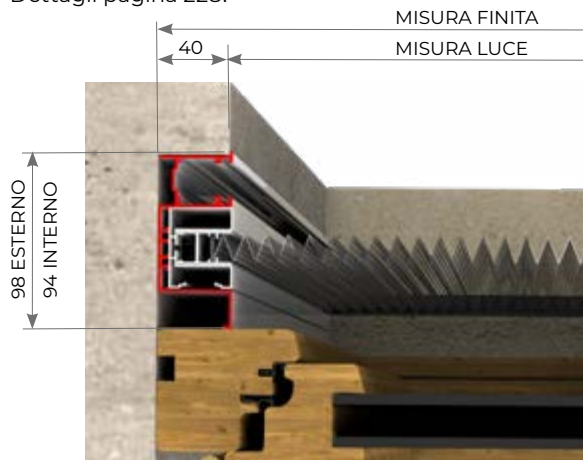

+ INCASSO - A 47

MISURA FINITA: verrà fornita con le stesse misure ordinate (max. ingombro)

MISURA LUCE: verrà fornita e addebitata con misure maggiorate: larghezza + (40x2)mm, x altezza + 40mm.
 Dettagli pagina 216.

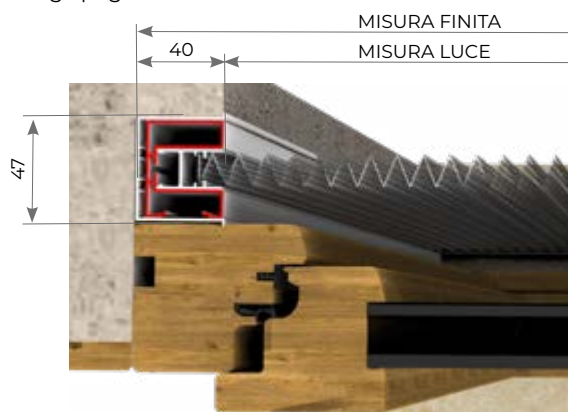

+ INCASSO - B 50

MISURA FINITA: verrà fornita con le stesse misure ordinate (max. ingombro)

MISURA LUCE: verrà fornita e addebitata con misure maggiorate: larghezza + (39x2)mm, x altezza + 39mm.
 Dettagli pagina 218.

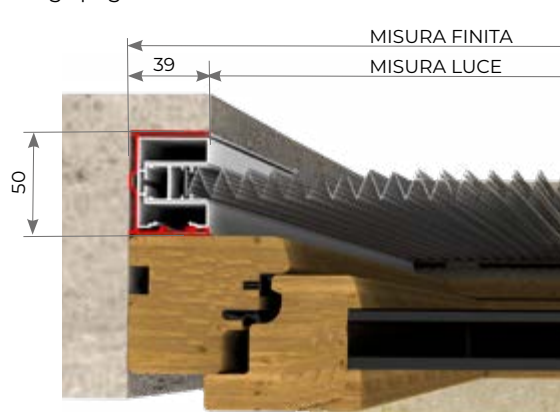

> 0.18 - ADATTATORE 45 - APPLICAZIONI

PER SISTEMA ALZA - SCORRI

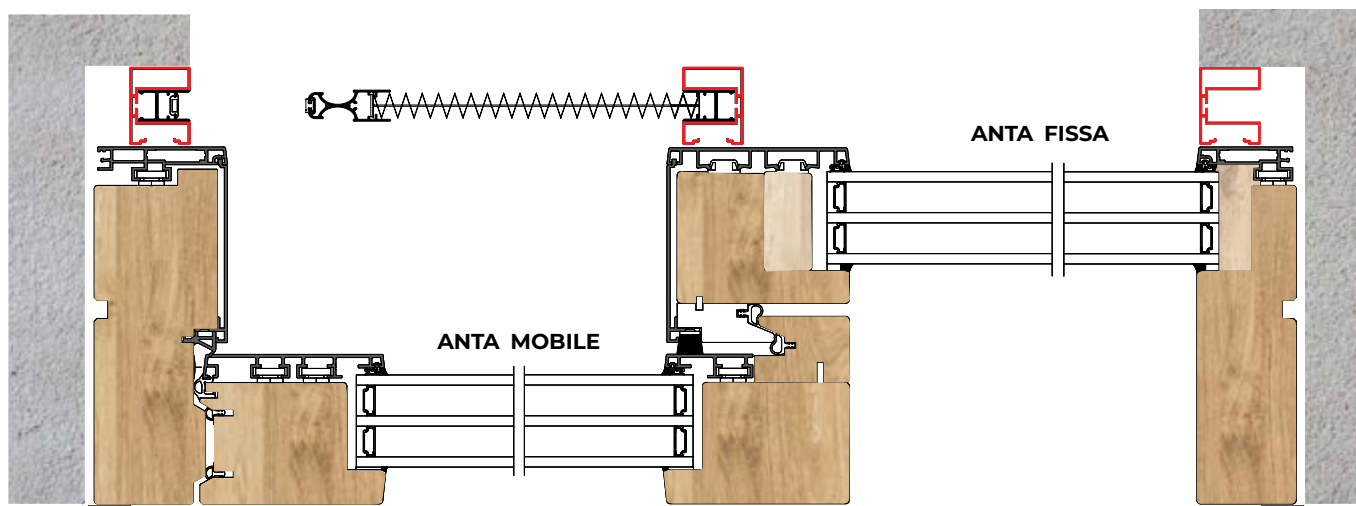

PER SISTEMA SCORREVOLE

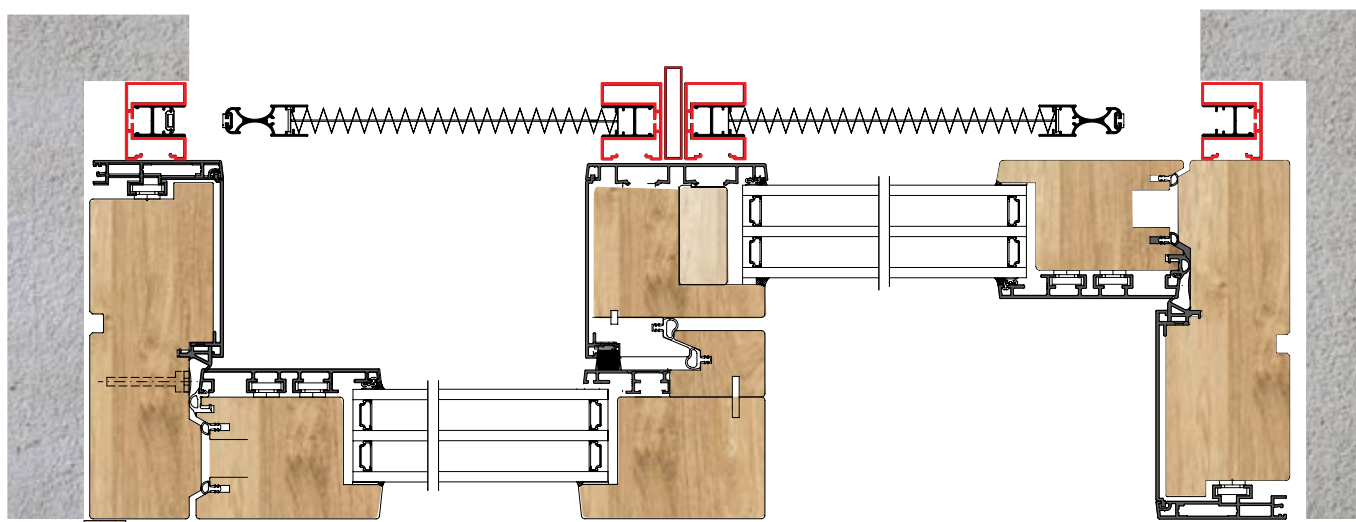



Articolo: ZANL0036TO

Zanzariera con rete plissettata, a comando frizionato.

Con un ingombro di soli 22mm diventa la soluzione ottimale per l'installazione in spazi ridotti. La guida a terra di appena 7mm rende il passaggio agevole.

È disponibile in due versioni, tutte fornite con rete nera e su richiesta con rete grigia.

0.22 LATERALE, particolarmente indicata per porte-finestre, ha un movimento laterale e prevede la realizzazione a una o due ante.

0.22 REVERSIBILE è una zanzariera per porte-finestre.

La sua particolare struttura, caratterizzata da due profili scorrevoli che permettono l'impacchettamento e l'estensione totale della rete da entrambi i lati, la rende molto indicata in abbinamento agli infissi scorrevoli.



LEGENDA ICONE VEDI PAG. 158

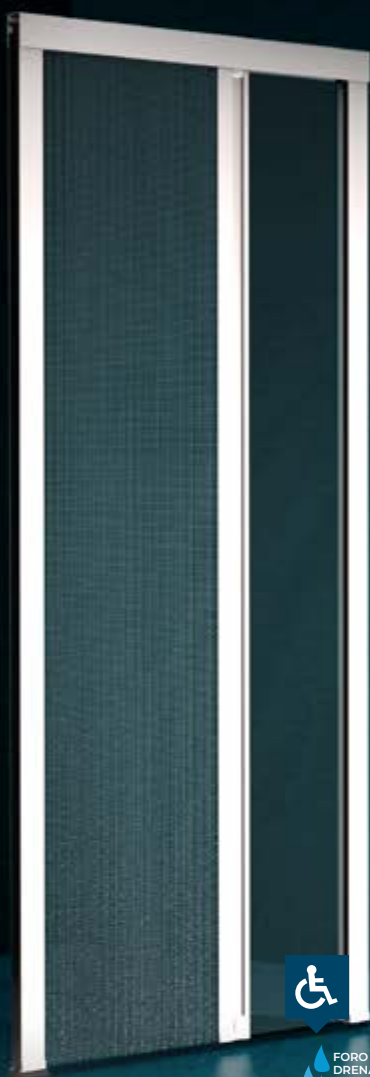

FORO DRENANTE

COLORI ACCESSORI NYLON

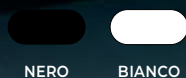

NERO BIANCO

COLORI ALLUMINIO RAL STANDARD

* FINITURA SEMILUCIDA ▲ FINITURA RUVIDA



RAL STANDARD MARMO LEGNO



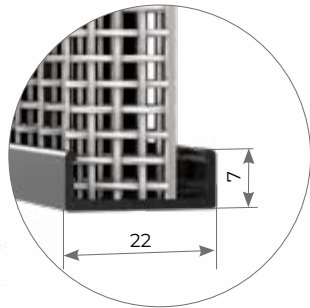
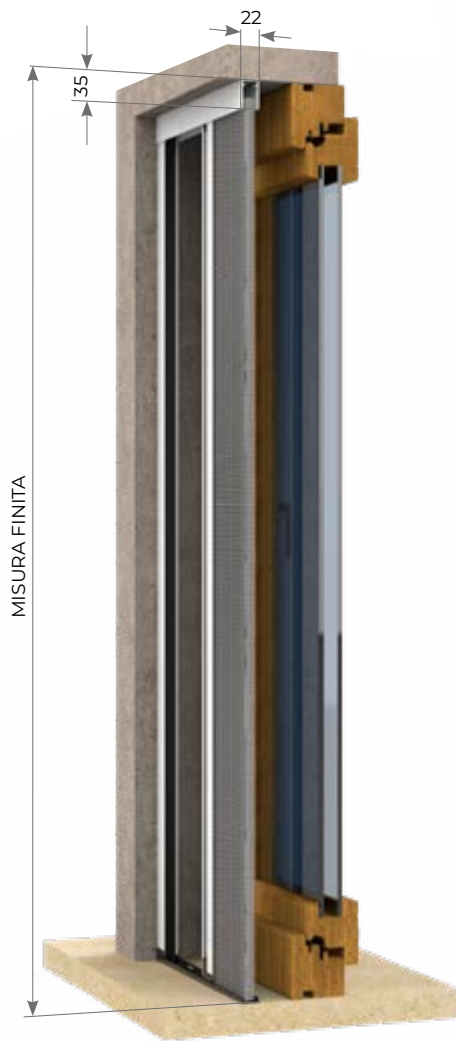

PIEGA RETE

RETE NERA STANDARD
A RICHIESTA GRIGIA

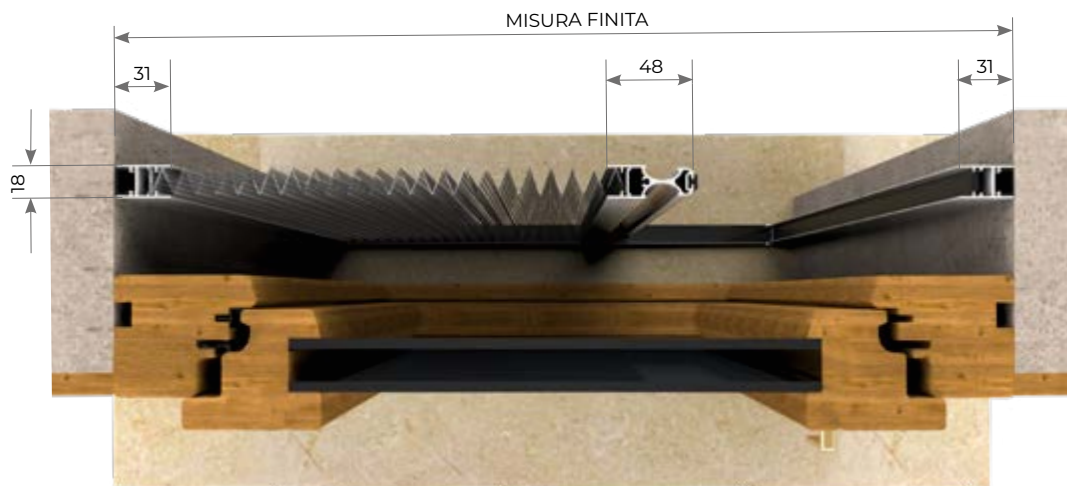

MISURE CONSIGLIATE mm

MISURA FINITA: la zanzariera verrà fornita con le stesse misure ordinate.

MISURA LUCE: (specificare) la zanzariera verrà fornita 3mm in meno sull'altezza.

0.22 TOP 1 ANTA LATERALE		
	L	H
MIN	-	600
MAX	2000	2600

0.22 TOP REVERSIBILE		
	L	H
MIN	-	600
MAX	2400	2600

PLISSETTATE

 **> 0.22 TOP** - VERSIONI

VERSIONE 2 ANTE

Articolo: ZANL0036TO

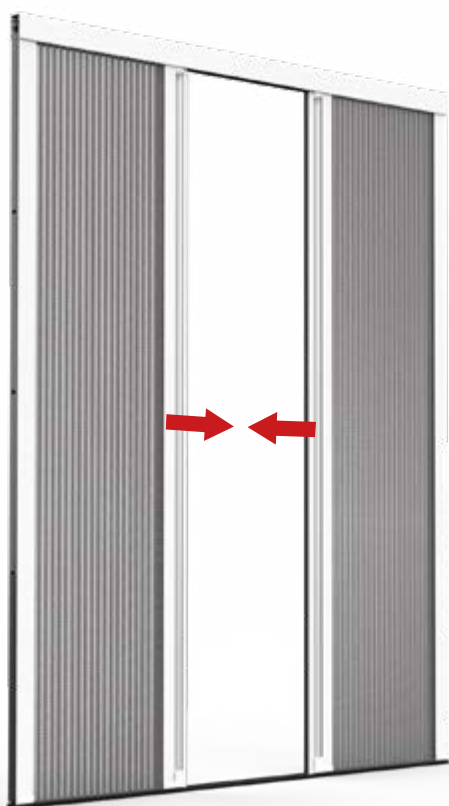

VERSIONE REVERSIBILE

Articolo: ZANL0118

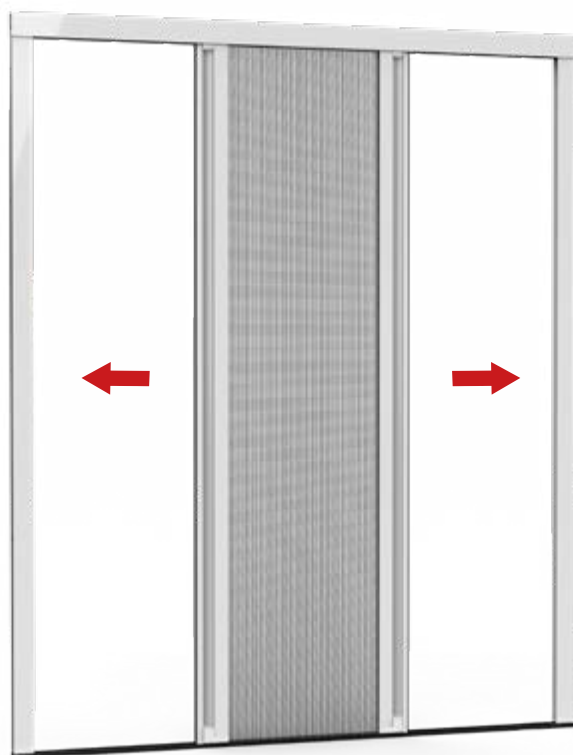

> 0.22 TOP

KIT COMPENSATORE

Per la compensazione di vani irregolari superiori a **10mm** fino a **25mm** si consiglia l'utilizzo del profilo compensatore.

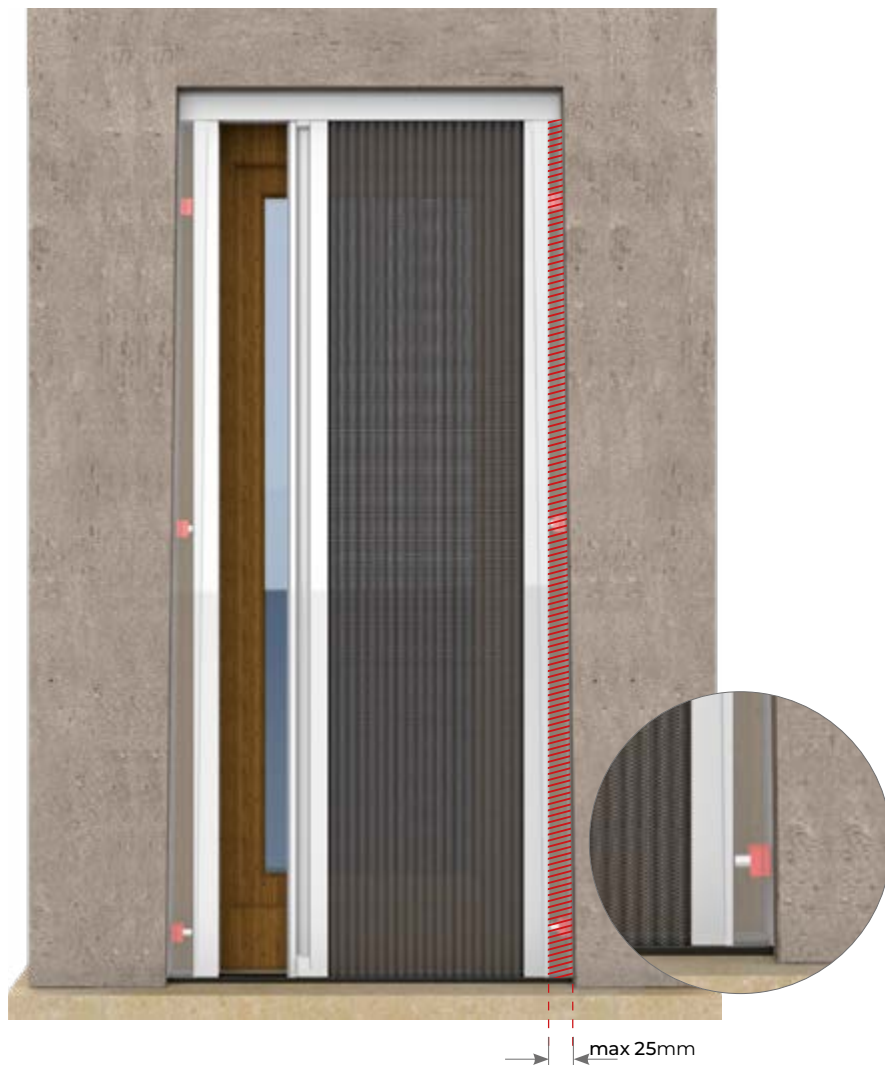

PLISSETTATE

COMPENSATORE

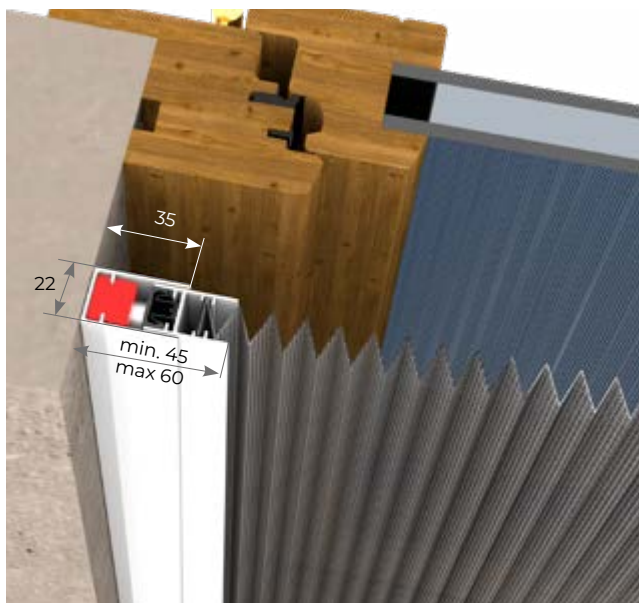

PROFILI DI FISSAGGIO



 > **0.27**



PATENTED: 002560003



Articolo: ZANV0062

Zanzariera con rete plissettata a comando frizionato.

Con un ingombro di soli 27mm diventa la soluzione ottimale per l'installazione in spazi ridotti.

Adatta per porte e finestre, ha un movimento verticale e può essere azionata con una comoda astina di 500mm (OPTIONAL)



ASTA
DI AZIONAMENTO

LEGENDA ICONE VEDI PAG. 158



COLORI ACCESSORI NYLON



NERO



BIANCO

COLORI ALLUMINIO RAL STANDARD

* FINITURA SEMILUCIDA



BIANCO
9010

*



AVORIO
1013

*



MARRONE
8017

*



BRONZO
VERNICIATO



ARGENTO
OX



MISURE CONSIGLIATE mm

MISURA FINITA: la zanzariera verrà fornita con le stesse misure ordinate.

MISURA LUCE: (specificare) la zanzariera verrà fornita 3mm in meno sul lato cassonetto.

0.27 VERTICALE	L	H
MIN	300	-
MAX	1400	2500

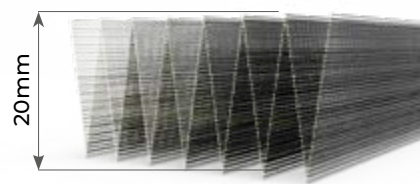

PIEGA RETE



PLISSETTATE

> **0.27** LATERALE



PATENTED: 002560003



LATERALE - Articolo: ZANL0051 REVERSIBILE - Articolo: ZANL0052

Zanzariera con rete plissettata a comando frizionato, con sistema di fissaggio a baionetta.

Con un ingombro di soli 27mm diventa la soluzione ottimale per l'installazione in spazi ridotti. La guida a terra di appena 7mm rende il passaggio agevole.

0.27 LATERALE, particolarmente indicata per porte-finestre, ha un movimento laterale e prevede la realizzazione a una o due ante.

0.27 REVERSIBILE è una zanzariera per porte-finestre.

La sua particolare struttura, caratterizzata da due profili scorrevoli che permettono l'impacchettamento e l'estensione totale della rete da entrambi i lati, la rende molto indicata in abbinamento agli infissi scorrevoli.



COLORI ACCESSORI NYLON

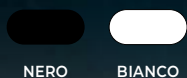

NERO

BIANCO

COLORI ALLUMINIO RAL STANDARD

* FINITURA SEMILUCIDA



BIANCO
9010

AVORIO
1013

MARRONE
8017

BRONZO
VERNICIATO

ARGENTO
OX

*

*

*

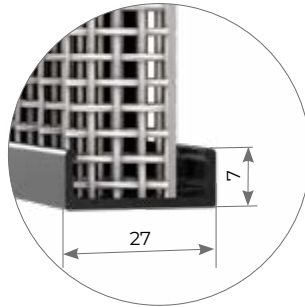
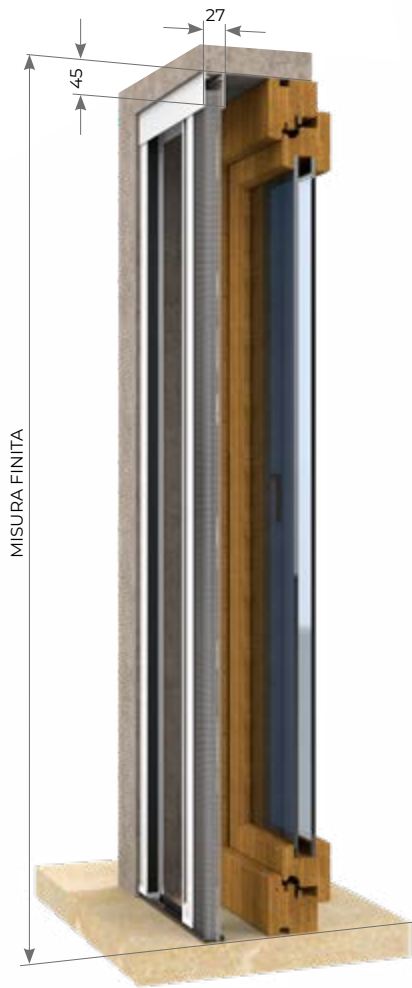

SISTEMA DI FISSAGGIO A BAIONETTA

MISURE CONSIGLIATE mm

MISURA FINITA: la zanzariera verrà fornita con le stesse misure ordinate.

MISURA LUCE: (specificare) la zanzariera verrà fornita 3mm in meno sulla larghezza.

0.27 1 ANTA LATERALE		
	L	H
MIN	-	600
MAX	2000	2600
0.27 REVERSIBILE		
	L	H
MIN	-	600
MAX	2400	2600

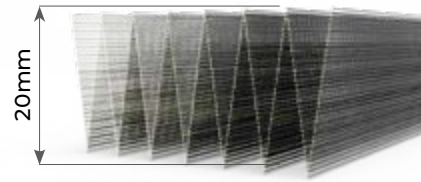

PIEGA RETE

RETE NERA STANDARD
A RICHIESTA GRIGIA

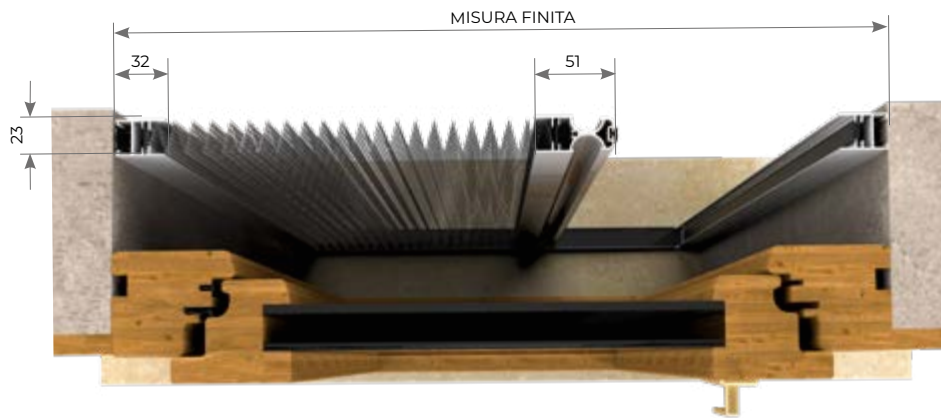

PLISSETTATE

DUE ANTE

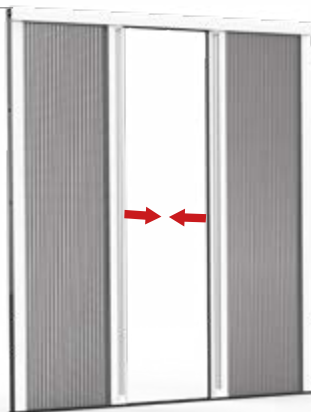

REVERSIBILE

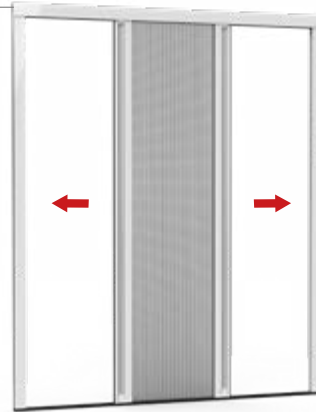

> LEGENDA SERIE PLISSÈ



MANIGLIA A PENDOLO

Maniglia in plastica che agevola la movimentazione del profilo scorrevole principalmente in sistemi da incasso.

PLISSÈ ZERO



MANIGLIA A SBALZO

Maniglia in pelle che agevola la movimentazione del profilo scorrevole principalmente in sistemi da incasso.

PLISSÈ ZERO



ASTA DI AZIONAMENTO

Sistema per agevolare lo scorrimento della zanzariera.

0.27 VERTICALE



KIT IMPACT

Riduce l'ingombro del pacco rete a zanzariera disattivata.

PLISSÈ ZERO

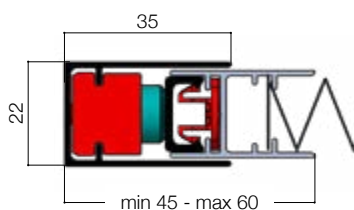

COMPENSATORE 0.22

Sistema per compensare i fuori squadra in altezza.

0.22

